



# Survivor DAB Radio All-in-1 20000

## Quick guide

421-38



Survivor DAB Radio All-in-1 20000

Item no. 421-38

Capacity: 20000 mAh / 74 Wh / 3.7V

USB-A output: 5V/2A

USB-C output: 5V/2A

USB-C input: 5V/3A

Solar Panel Voltage: 5V, 65 mA (0.33W max)

Hand crank power: 5V/2A max

Product weight: 890g

[www.sandberg.world](http://www.sandberg.world)

[info@sandberg.world](mailto:info@sandberg.world)

Made in China

Sandberg A/S

Bregnerødvej 133D,  
3460 Birkerød, Denmark



**NOTE:** If not used regularly, please recharge the radio at least every 3 months to maintain optimal performance.



# 5

Years  
Warranty

## Warranty

There is a five-year warranty on your Sandberg product. Please read the warranty terms and register your new Sandberg product at [www.sandberg.world/warranty](http://www.sandberg.world/warranty)

[www.sandberg.world](http://www.sandberg.world) Support: [helpdesk.sandberg.world](mailto:helpdesk.sandberg.world)



For information on handling electronic waste, see [www.sandberg.world/weee](http://www.sandberg.world/weee)

## Overview

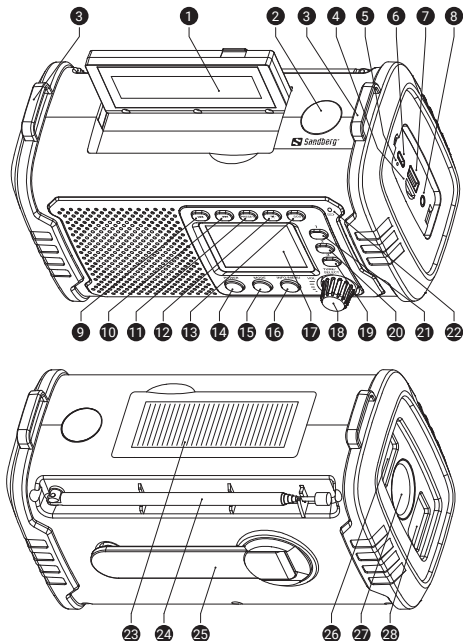

1. Reading light
2. Compass
3. Lanyard attachment point
4. TF card interface
5. Charging/discharging indicator light
6. USB-C Input/Output
7. USB-A Output
8. Headphone jack
9. Previous button
10. Next button
11. PRESET button
12. LED button
13. SOS button
14. POWER button
15. MODE button
16. INFO/MENU button
17. TFT display screen
18. TUNE/SELECT/VOL knob
19. Key 3
20. Key 2
21. Key 1
22. Solar/generator power indicator
23. Solar panel
24. Telescopic Antenna
25. Hand crank handle
26. Low beam
27. High beam
28. Low beam

## Charging the internal battery

Hand crank

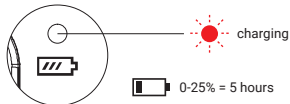

Solar panel

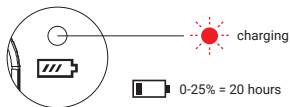
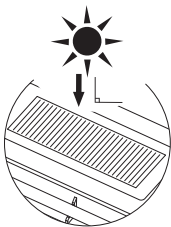

AC charger

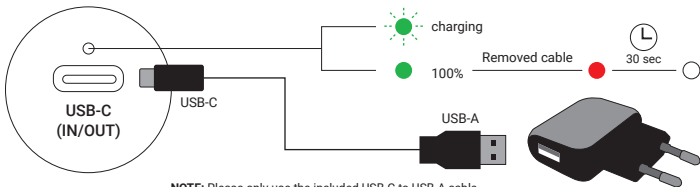

**NOTE:** Please only use the included USB-C to USB-A cable.

## Charge devices

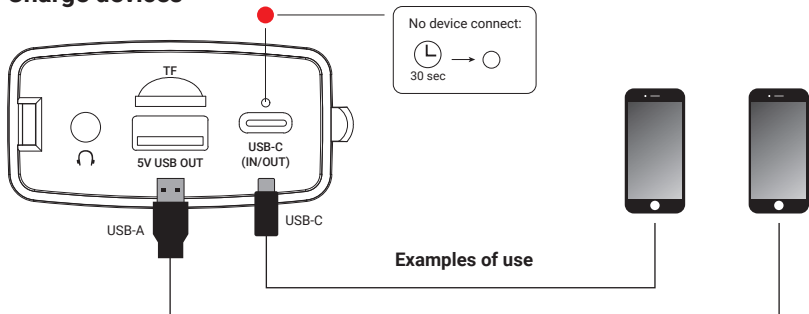

## Button functions

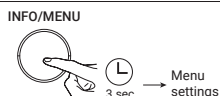
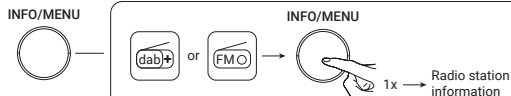
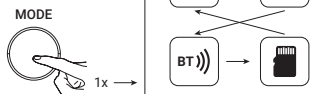

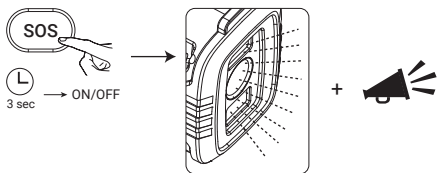
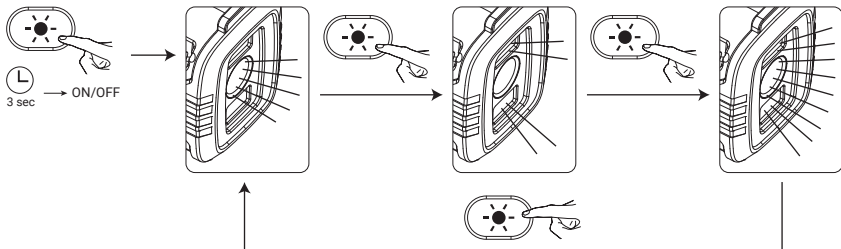

## Reading light

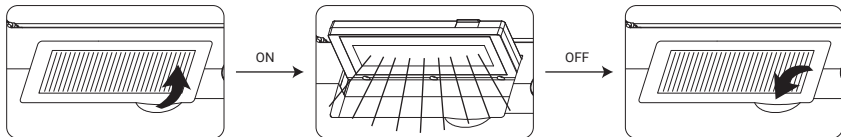

## DAB and FM Mode

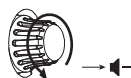
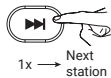
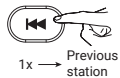
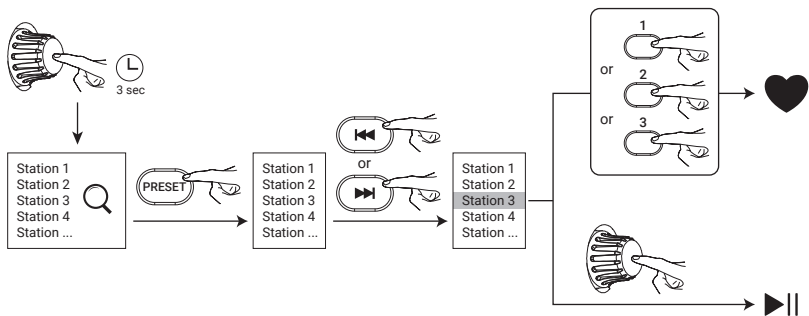
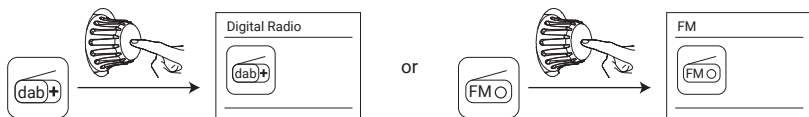

## Bluetooth Mode

### Pairing with Bluetooth device

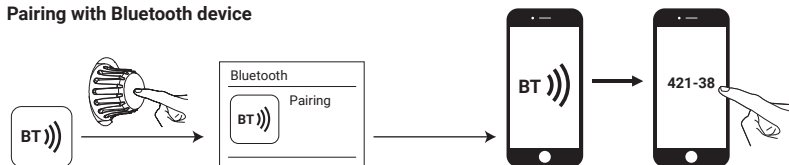

### Using

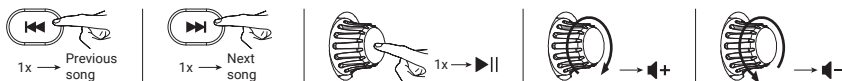

## TF Mode

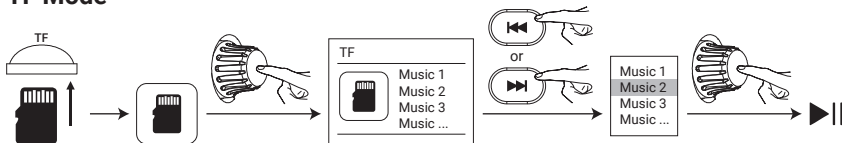



## Declaration of Conformity

Manufacturer: Sandberg A/S  
Address: Bregneroevej 133D, 3460 Birkerød, Denmark  
Product description: Audio device radio, Bluetooth speaker & MP3 player.  
Product name/Type no: Survivor DAB Radio All-in-1 20000 / 421-38

We declare under our sole responsibility that the products, to which this declaration relates, are in conformity with the Council Directives on the approximation of the laws of the EEC Member States relating to the following:

### Directives

RED Directive 2014/53/EU  
RoHS 2.0 Directive 2011/65/EU Annex II (EU) 2015/863 with amendment 2017/2102

### And standards

EN 50663:2017  
EN 301 489-1 V2.2.3 (2019-11)  
ETSI EN 301 489-17 V3.3.1 (2024-09)  
EN IEC 62368-1:2024+A11:2024  
EN 62321-5:2014  
EN 62321-4:2014+A1:2017  
EN 62321-7:2015  
EN 62321-7-2:2017  
EN 62321-6:2015  
EN 62321-8:2017  
ETSI EN 300 328 V2.2.2 (2019-07)  
EN 55032:2015+A11:2020  
EN 55035:2017+A11:2020

Date: 12<sup>th</sup> January 2026

Location: Birkerød, Denmark

Name: Anders Petersen

Signature

**CE letter of  
conformity**